



STRUCTURAL HEALTH MONITORING AND DAMAGE DIAGNOSIS: BASED ON EMBEDDED ALGORITHM AND VISUALIZED USER INTERFACE

Kung-Chun Lu¹, Yuan-Sen Yang², Chin-Hsiung Loh³, Jerome P. Lynch⁴ and K. H. Law⁵

ABSTRACT

A wireless sensing unit is designed for application in structural monitoring and damage detection system. Embedded in the wireless monitoring module, a two-tier prediction model, using auto-regressive (AR) and the autoregressive model with exogenous inputs (ARX) is used for obtaining the damage sensitive feature. To validate the performance of the proposed wireless monitoring and damage detection system, an almost full scale single-story RC-frame with brick wall system is instrumented with a wireless monitoring module system. White noise and seismic ground motion records are applied to the base of the structure using a shaking table. Pattern classification method is then adopted to classify the structure as damaged or undamaged using the AR time series coefficients as feature vector. The demonstration of damage detection methodology is shown to be capable of identifying the damage using wireless sensing unit with monitor module. The accuracy and sensitivity of today's MEMS-based vibration sensors are approaching the stringent requirements imposed by structural sensing.

Keywords: structural health monitoring, wireless monitoring sensors, damage detection, time series analysis

INTRODUCTION

Systems that detect damage in large structures such as buildings and bridges can improve safety and reduce maintenance costs. The design of such system is the goal of structural health monitoring (SHM). Many existing SHM techniques attempt to detect damage by continuously recording structural response to ambient excitation. Such an approach might be infeasible for a wireless sensor network design for long-lived operation. Recently, researchers have demonstrated that wireless sensing networks can be successfully used for structural health monitoring [1,2]. The design of the wireless sensing unit is optimized for the application of structural monitoring and includes three major subsystems: the sensing interface, the computational core, and the wireless communication system. The sensing interface is responsible for converting analog sensor signals on multiple channels into 16-bit digital formats. The digital data is then transferred to the computational core by a high-speed serial peripheral interface (SPI) port. Abundant external memory (128 kB) is associated with the computational core for local data storage and analysis. The Maxstream XStream wireless modem, operating on the 2.4 GHz wireless band, is used for wireless communication between sensors and the

¹ Graduate student, National Taiwan University, Taipei, Taiwan, r92521247@ntu.edu.tw

² Associate Research Fellow, National Center for Research on Earthquake Engineering, Taiwan, ysyang@ncree.org.tw

³ Professor, National Taiwan University, Taipei, Taiwan, loh0220@ccms.ntu.edu.tw

⁴ Assistant Professor, University of Michigan, Ann Arbor, MI 48109, USA, jerlynch@umich.edu

⁵ Professor, Stanford University, Stanford, CA 94305, USA, law@stanford.edu

data repository. The advantage of using wireless monitoring system is: 1) easy to install, 2) accurate with wireless data identical to data collected from a tethered data acquisition system, and 3) highly reliable with no data loss in the wireless channel. MEMS sensor and wireless solution provide a strong potential for unit installation in automatic SHM and damage detection.

Damage detection has been extensively studied over the past 30 years and the literature on the subject is rather immense. Doebling *et al.* [3] gives a comprehensive survey of vibration based global damage detection techniques. Recently, a damage detection approach using time series analysis of vibration signals was proposed by Los Alamos National Laboratory (LANL) [4]. It is based on the “statistical pattern recognition” paradigm. The method is very attractive for the development of an automated monitoring system. Later on a procedure based on the time series analysis of vibration signals for damage detection and localization within a mechanical system [5]. The standard deviation of the residual error, which is the difference between the actual measurement and the prediction derived from a combination of the AR and ARX models, is used as the damage-sensitive feature to locate damage. With a flexible and capable hardware design on wireless sensing unit, the unit can be implemented with the computational task required by a SHM and damage detection system. At the present stage, there is no difficulties to fabricated from advanced embedded system technologies to employ a spread-spectrum wireless modem for peer-to-peer communication between sensing unit and computational core for local damage detection [6,7].

In this study, a wireless monitoring system assembled from wireless sensor prototypes proposed by Wang, Lynch and Law (2005) is installed on a full-scale RC frame structure with brick wall in the laboratory. A damage detection method proposed by Sohn and Farrar (2001) is adopted to continuously identify the structural damage situation during different intensity level of ground shaking based on the AR model coefficients calculated by the wireless sensors. A user interface visualization system in connection with wireless sensing system is also implemented.

TEST STRUCTURES

Two full-scale RC frames are designed and constructed at the National Center for Research on Earthquake Engineering (NCREE) in Taipei, Taiwan. These frames have the same RC frame design with different brick wall constructions to study the dynamic behaviors of different brick walls along out-of-plane directions. Figure 1a shows the photo of the test specimen. The two types of specimens have different type of construction with brick walls, which include a pure frame (PF) with a frame with 12cm thick post-laid brick walls (A1F), and a frame with 12cm thick pre-laid brick walls (B1F). The distances between the center lines of columns along X and Y directions are 2.1m and 3.05m, respectively. The height of the columns is 2.8m. The column section is 0.35 by 0.3m with eight #5 longitudinal steel bars and #3 transverse ties with spacing of 0.25m. The nominal strengths of concrete and steel are 180kg/cm² and 2800kg/cm², respectively. The 10-ton top floor and the 13-ton foundation are both designed to be strong comparing with the columns and are considered as rigid diaphragms. Preliminary modal analysis using displacement-based beam-column elements with fiber sections using OpenSees (ver. 1.7.1) (McKenna and Fenves, 2000) shows that the dominant natural periods of the pure frame specimen is 0.24sec, and the A1F and B1F are 0.23sec, respectively. The analyzed dominant mode shape is shown in Figure 1b. As shown in Figure 2 (top view or side view), each frame consists of four RC columns, a strong top floor and a strong foundation. Due to lacking understanding of the out-of-plane brick wall behaviors at present time, further studies on numerical simulation are required in the near future.

SEISMIC BASE EXCITATION

There are three objectives in the test: 1) to assess the accuracy of the wireless monitoring systems, 2) to utilize the computational capabilities of the sensing unit design for continuous damage detection, 3)

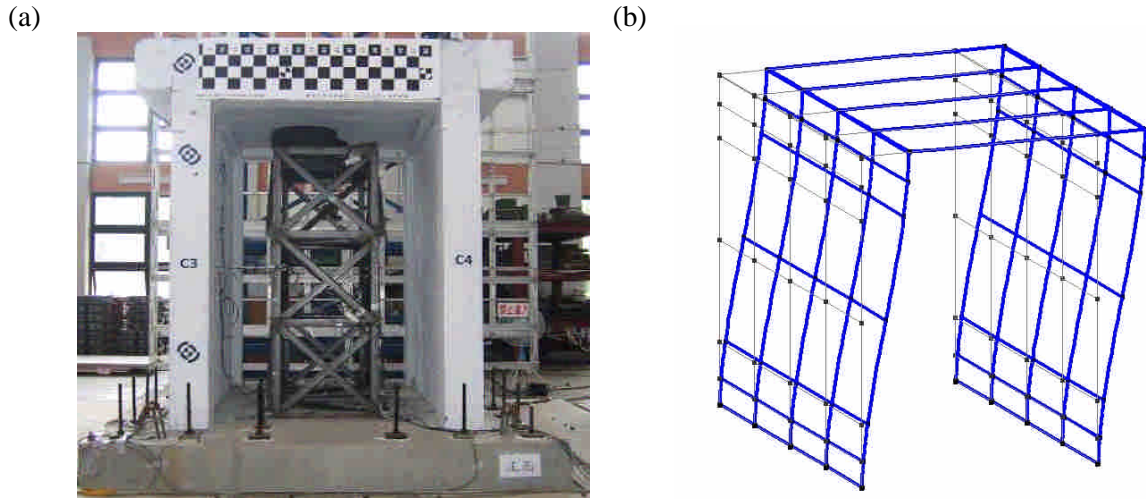

Figure 1: (a) Photo of the specimen B1F. (b) The first dominant mode of the frame structure.

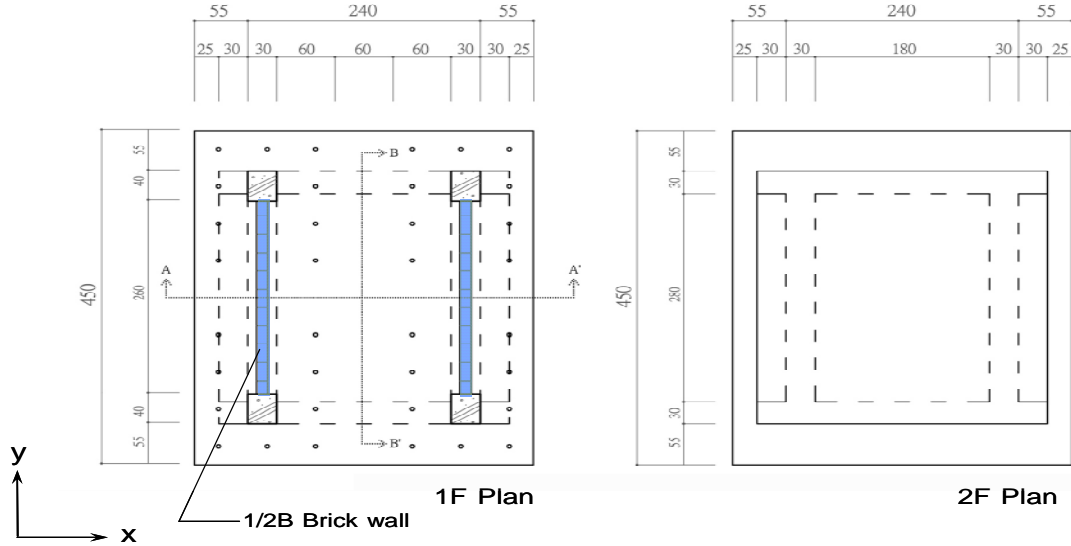

Figure 2a: Top view of the test specimen (A1F).

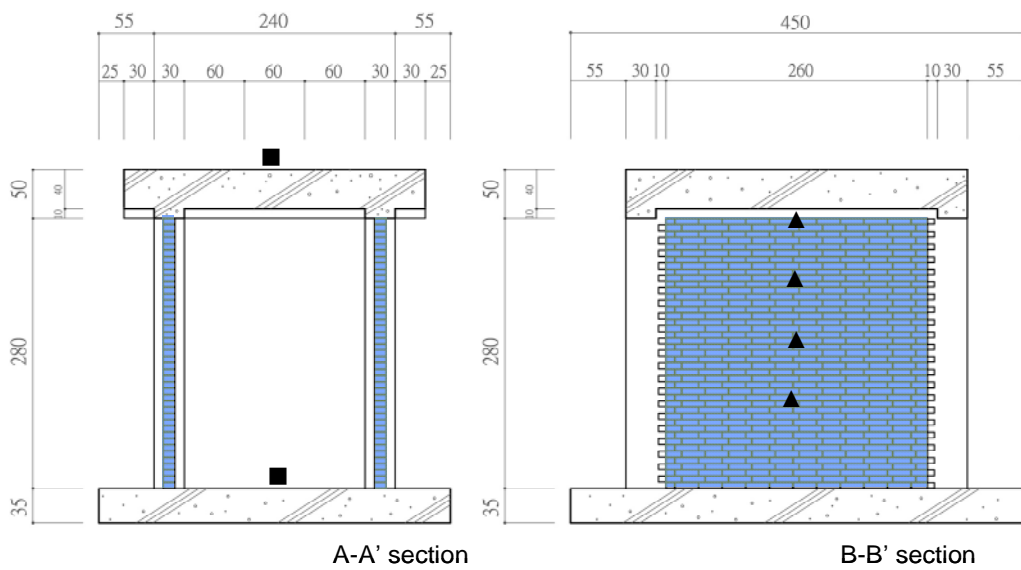

Figure 2b: Side view of the test specimen. Locations of accelerometers (■) and LVDT (▲) are also shown.

to evaluate the reliability of damage detection and the capability of visualization on real time structural damage monitoring. Both conventional wired sensors and the wireless sensing unit are designed to install on each specimen to monitor their response excited by the shake table motions. Accelerometers (Setra 141A in range of $\pm 4g$) are installed at the top and basement of the floor and four Linear Variable Differential Transformer (LVDT) displacement measurement devices are positioned on each brick wall. to measure the deformation of the wall. To quantify the accuracy of the wireless monitoring system, the laboratory data acquisition system (Pacific Instrument Series 5500 data acquisition classis) is also used to offer high-resolution data acquisition with sampling rate of 200 Hz. In the wireless communication a sampling rate of 100Hz is used. To excite the RC brick wall structure, various base excitations are applied by the shaking table. It should be noted that the white noise and seismic ground motion records are applied back to back sequentially in uni-axial direction. Table 1 summarizes the excitations during the laboratory study. The response of the test structure to the Chi-Chi 1999 earthquake TCU078 seismic ground motion record is shown in Figure 3 (for case of excitation 1800 gal). Comparison on the recorded roof acceleration response between wired and wireless system nearly identical results on the data acquisition are observed. The Fourier amplitude spectrum of floor acceleration response from white noise excitation at different stage of the structure (after different level of earthquake ground motion excitation) is also shown. The change of dominant frequency of the response signal is obvious in both test cases. The restoring force diagram of the test structure from

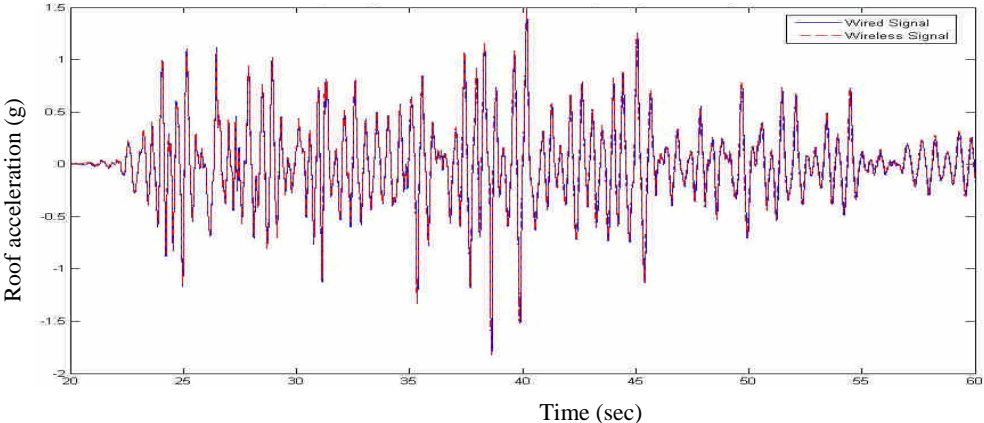

Figure 3: Comparison on roof response of the test specimen to Chi-Chi TCU078(1800 gal) strong motion from both conventional accelerometer and wireless sensing unit

Table 1: Applied ground excitation during dynamic testing of the structure; Case A: RC pure frame, Case B: RC frame in-filled with 1/2B post-laid brick walls.

Case A: PF		Case B: A1F	
Excitation	Intensity	Excitation	Intensity
1. White Noise 1	50 gal	White Noise 1	50 gal
TCU078EW	150 gal	TCU078EW	150
2. White Noise 2	50 gal	White Noise 2	50 gal
TCU078EW	500 gal	TCU078EW	500
3. White Noise 3	50 gal	White Noise 3	50 gal
TCU078EW	1000 gal	TCU078EW	1500
4. White Noise 4	50 gal	White Noise 4	50 gal
5. White Noise 5	50 gal	TCU078EW	2100
6. White Noise 6	50 gal	White Noise 5	50 gal
TCU078EW	1500 gal		
7. White Noise 7	50 gal		
TCU078EW	1800 gal		
8. White Noise 8	50 gal		

different test stage is also examined. Figure 5a shows the floor acceleration responses, Fourier amplitude spectrum, and restoring force diagram from test case A (PF), and Figure 5b shows the same plot for test case B (A1F). Since the acceleration response data and the relative displacement of the structure can be collected from the wireless monitoring module, then the Fourier amplitude spectrum and the restoring force diagram of the structure for each level of ground excitation can be constructed immediately. These results indicate for different intensity level of excitation the structural system behaves different level of damage.

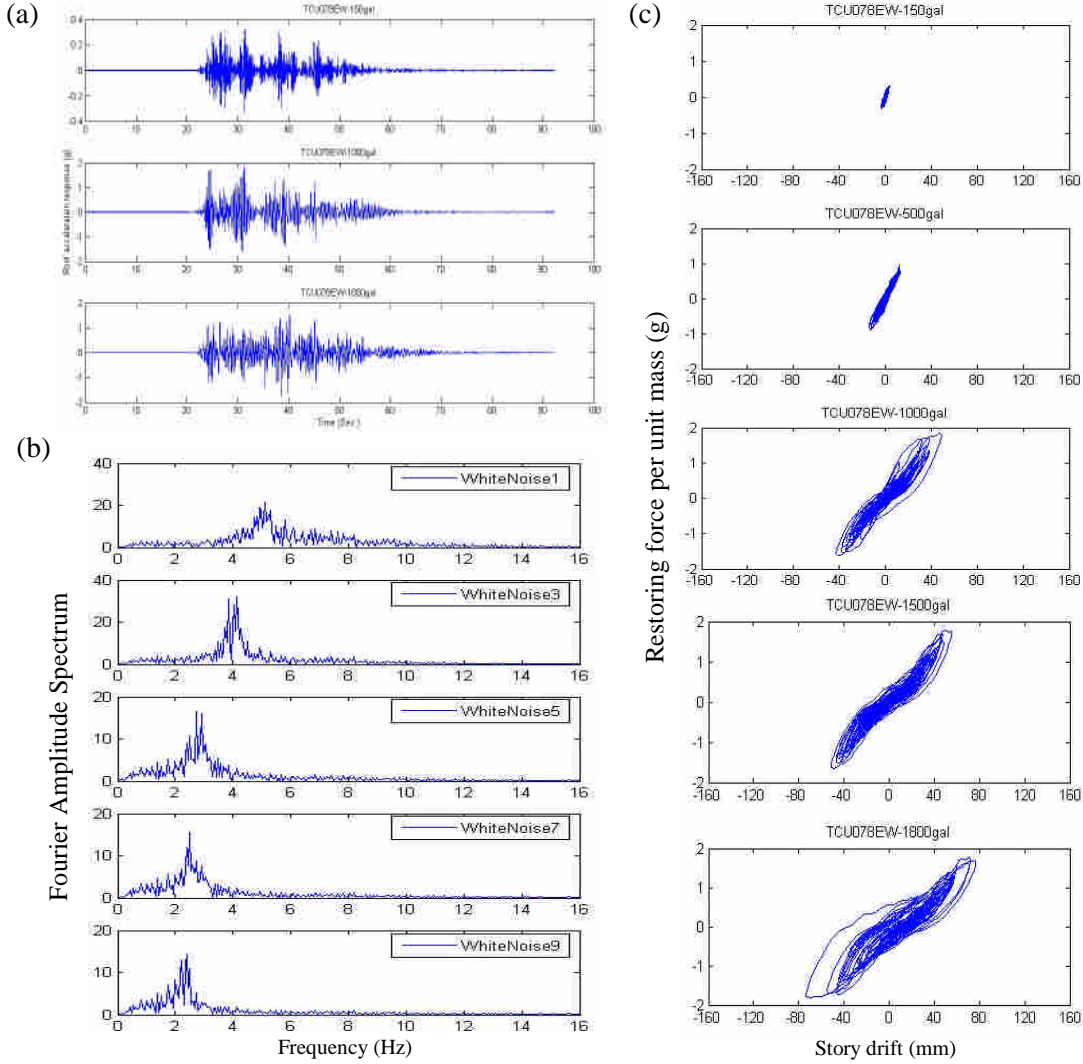

Figure 5a: Plot of floor acceleration responses, Fourier amplitude spectrum, and restoring force diagram from test case A (PF); (a) Acceleration response for input PGA=150gal, 1000gal, and 1800 gal, (b) Fourier amplitude spectrum of ambient signal from different stage of test, (c) Restoring diagram of the test structure from different test stage.

**COMMUNICATION PROCEDURE FOR
TWO-TIER TIME SERIES DAMAGE DETECTION**

Approaches based upon the statistical pattern recognition paradigm, proposed by Sohn *et al.* 2001, appear promising and easy to be implemented in the computational core of sensing unit to detect the structural damage at different stage. The major program row for damage detection using wireless monitoring module system (WiMMS) is shown in Figure X. The damage detection algorithm and data broadcast between sensing unit and the receiver (server) are described as follows:

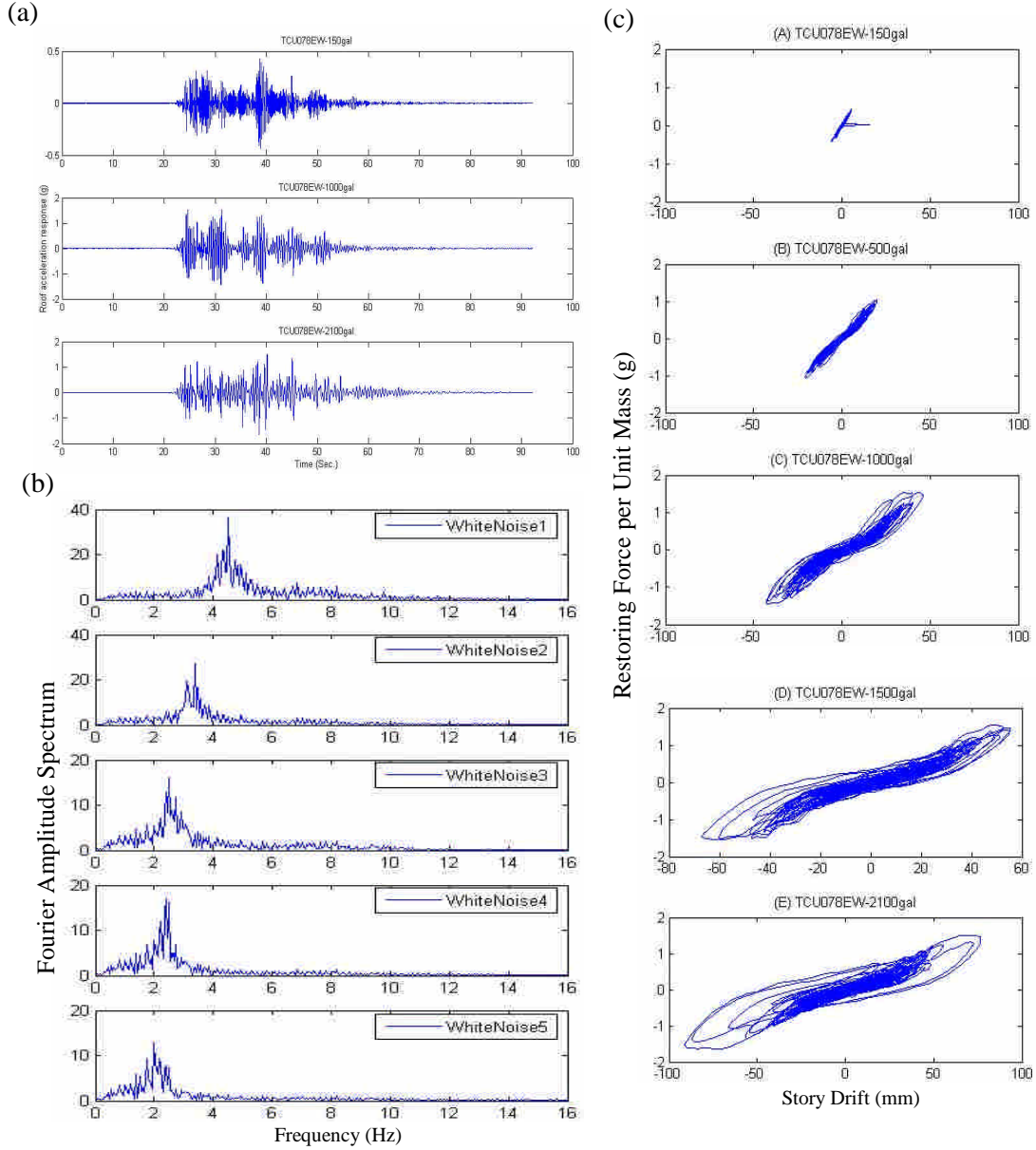

Figure 5b: Plot of floor acceleration responses, Fourier amplitude spectrum, and restoring force diagram from test case B (A1F); (a) Acceleration response for input PGA=150gal, 1000gal, and 2100 gal, (b) Fourier amplitude spectrum of ambient signal from different stage of test, (c) Restoring diagram of the test structure from different test stage.

1. The wireless sensing unit collects a series of structural responses (assumed as a reference data) and broadcast the collected structural responses to the receiver (in server side).
2. Under the assumption of stationary response time history of the structure at a single measurement location (for case of white noise excitation), the response data, y , an autoregressive (AR) time series model is fitted to the data.

$$y_m(k) = \sum_{i=1}^p \phi_i y_m(k-i) + r_{AR}^m(k) \quad (1)$$

where ϕ_i is the i -th AR coefficient, p is the order of the AR model ($p=22$ is assumed in this study), r_{AR} is the residual error and m indicates m -th time series. It is assumed that this error between the measurement and the prediction obtained by the AR model is mainly caused by the unknown external input. A set of reference AR coefficients are obtained. Therefore, for each set of reference data, an ARX model is employed to reconstruct the input/output relationship between $r_{AR}(t)$ and $y(t)$:

$$y_n(k) = \sum_{i=1}^a a_i y_n(k-i) + \sum_{j=0}^b \beta_j r_{AR}^n(k-j) + \varepsilon_{ARX}^n(k) \quad (2)$$

where a and b are the orders of the ARX model (in this study $a=12$ and $b=10$ are assumed). The final residual error of the ARX model, ε_{ARX}^n , is defined as the damage sensitive feature. This model parameter estimation procedure is conducted in the server side. This AR-ARX time series models are determined for the structure in its undamaged state. A series of sample data are chosen to conduct the estimation of ARX model parameters. It is form a data base of baseline models describing in its undamaged state.

3. A new response data is developed from the structure. Measured response data from the structure at different state (assumed as a damage state occurred). The same AR model is fit to the new signal, $\tilde{y}(k)$.

$$\tilde{y}(k) = \sum_{i=1}^p \tilde{\phi}_i y(k-i) + \tilde{r}_{AR}(k)$$

This estimation is conducted in the wireless sensing unit from structural side and broadcast the new set of AR coefficients to the server side.

4. In the sever side, the new AR coefficients is compared with each AR model of the signal from the reference data base so as to select a signal from $y_n(k)$ by minimizing the following difference of the AR coefficients:

$$difference = \sum_{i=1}^p (\phi_i - \tilde{\phi}_i)^2 \quad (3)$$

The selected signal is defined as the reference signal. The ARX model coefficients obtained from the reference signal $y_n(k)$ and the standard deviation of $\varepsilon_{ARX}(k)$ are broadcasted to sensing unit.

5. The sensing unit on the structure will receive the selected ARX model coefficients from sever and calculate the standard deviation, $\sigma(\tilde{\varepsilon}_{ARX})$, of the newly measured data for this model. A new estimated residual ratio is calculated:

$$h = \frac{\sigma(\varepsilon_{ARX})}{\sigma(\tilde{\varepsilon}_{ARX})} \quad (4)$$

6. The sensing unit broadcast the ratio h to the server. The standard deviation ratio of the AR-ARX residual error is approximately 1 for undamaged situation and is exceeding 1 for damaged case.

Figure 6 shows the major program row for damage detection strategy in a wireless monitoring system. The AR-ARX time series damage detection method is well suited for automated execution by a wireless monitoring system.

VALIDATION OF THE EMBEDDED AR-ARX DAMAGE DETECTION METHOD

Results from WiMMS system To validate the AR-ARX damage detection method, the structure in an undamaged state is excited using white noise excitation. Based on the two-tier time series damage detection method the reference data are collected. After each test, the wireless sensors are communicated with server and are commended to determine the AR-ARX model. Follow the procedures mentioned in the previous section, the ratio of AR-ARX two-tier model residual errors can be generated. Table 2 shows the result from Case A (PF) and Case B (A1F). Since the white noise excitation was conducted after each earthquake excitation with increasing intensity level), the output ratio of residual error becomes more and more significant which indicates the degree of damage in the structure.

Result from offline analysis In order to verify the accuracy of the damage detection through wireless monitoring module data collected from wired system (from NCREE data acquisition system) are also used to conduct the offline damage detection using the same procedure. Figure 7 plots the ratio of AR-ARX two-tier model residual error for test Case A (PF) and test Case B (A1F). It is observed that the estimated residual error also indicates increase after each shaking table test. The estimated ratio of AR-ARX two-tier model residual error from offline analysis is larger than the result from wireless sensing unit. This phenomenon can be explained as the difference on the sampling rate between these two approaches (100Hz for wireless sensing unit and 200Hz for wireless system).

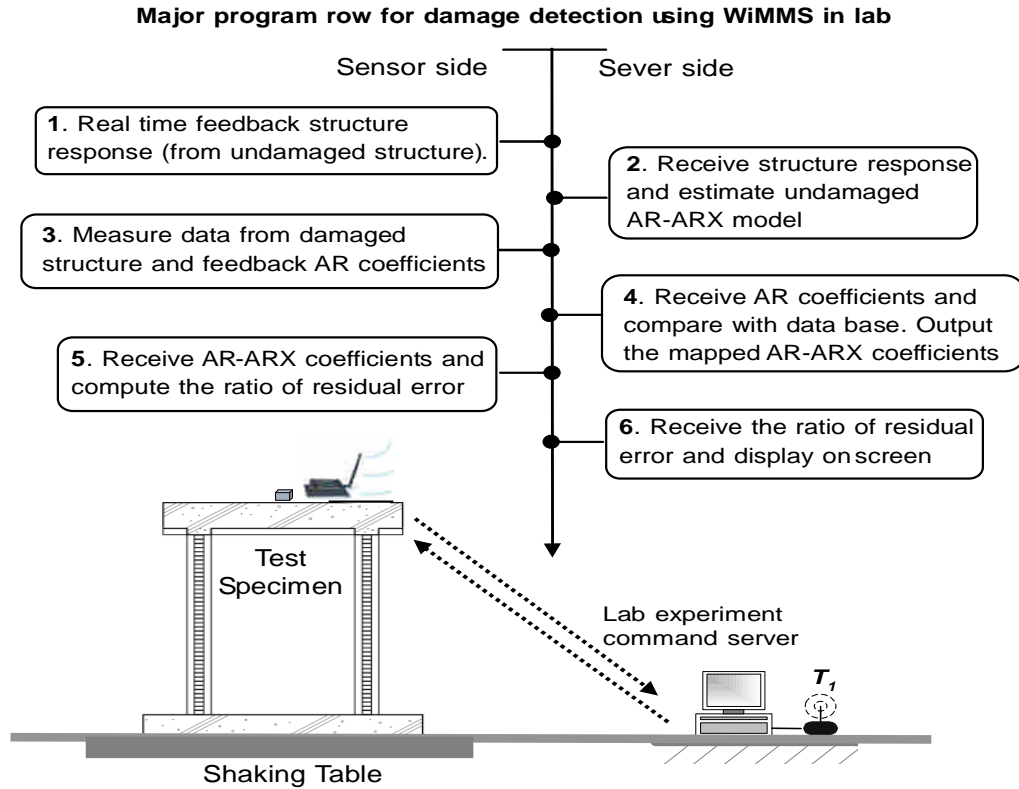

Figure 6: Implementation of the AR-ARX damage detection strategy in a wireless monitoring system to conduct the continuous damage detection of large structural testing in the laboratory.

Table 2a: Estimated ratio of residual error by wireless sensing unit from different test case of pure frame structure (PF)

Test case	Ratio of residual error
1. White Noise 1	Generate Data Base
2. White Noise 2	0.955
3. White Noise 3	0.930
4. White Noise 4	2.354
5. White Noise 5	1.706
6. White Noise 6	1.407
7. White Noise 7	1.616
8. White Noise 8	3.003

Table 2a: Estimated ratio of residual error by wireless sensing unit from different test case of frame structure with brick wall(A1F).

Excitation	Ratio of residual error
1. WhiteNoise1	(Generate data base)
2. WhiteNoise2	0.902
3. WhiteNoise3	1.027
4. WhiteNoise4	1.377
5. WhiteNoise5	1.545

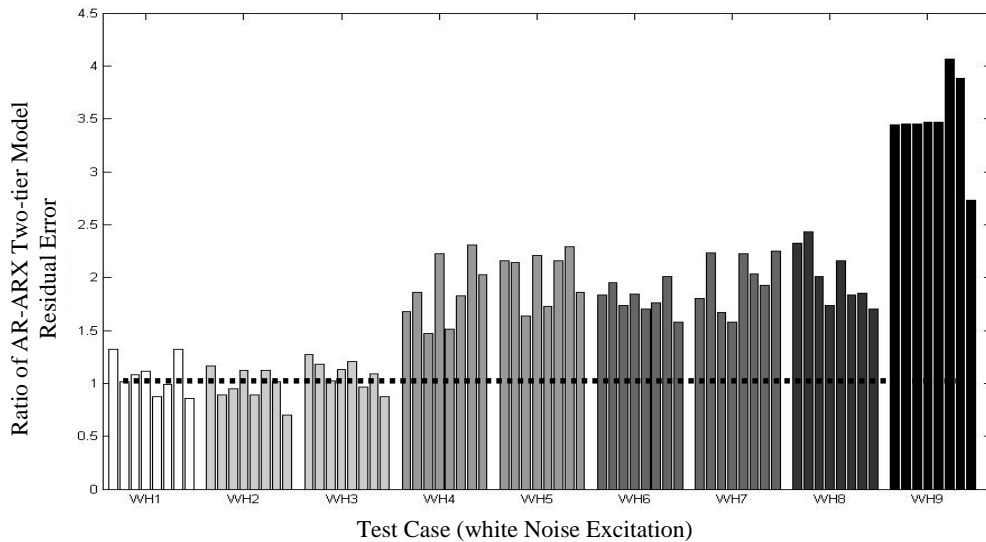

Figure 7a: Ratio of AR-ARX two-tier model residual error from test of pure RC frame.

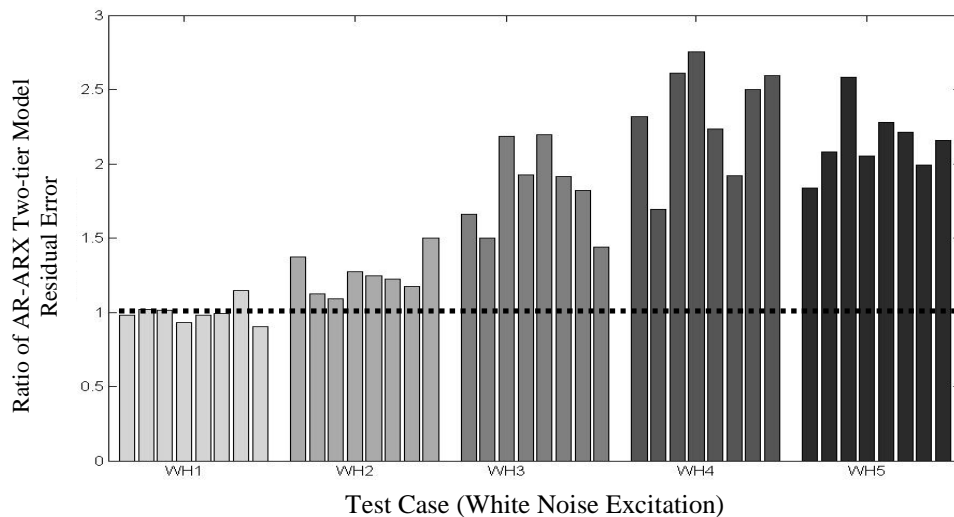

Figure 7b: Ratio of AR-ARX two-tier model residual error from test of RC frame in filled with 1/2B post-laid brick walls.

INTEGRATION OF WIMMS AND LABVIEW (VISUALIZATION)

LabVIEW is a popular Graphically Programming Language. There are three basic communication subroutines in Visualized Interpretation (VI) in LabVIEW: receive wireless package VI, transmit wireless unsigned short, and transmit wireless single float (as shown in Figure 8a). In this study three major programs are developed under LabVIEW: Real-time display (as shown in Figure 8b), results on AR model estimation (as shown in Figure X) and results on damage detection (as shown in figure 8c). In Figure 9: There are three pages to display. Page1 is the real time display on response time history and Fourier amplitude spectrum. On this page (A) indicates the pge number, (B) Parameter Box: In this box, user can set the parameters of this program. These parameters are the order of AR and ARX, start point of AR analysis, and data length and COM port parameters; (C) Real-time display roof acceleration response. In this chart the structure response is display directly on the screen. (D) Real-time display the moving window Fourier Amplitude Spectrum, by observing this chart, user can get the information of frequency domain (variance of nature frequency). In Figure2: This page shows the results of AR analysis on which (B) shows the AR coefficients which are received wirelessly from wireless sensing unit; (C) shows the roots of transfer function; (D) presents the poles of transfer function by polar coordinate; and (E) shows the nature frequency which is extract by solving the poles

of transfer function. In Figure 9: This page shows the results of damage diagnosis in which (B) shows data base which is read from specific TXT file (which is prepared from the acceleration response when the structure is undamaged). The data base includes four information: AR parameters, ARX parameters and the standard deviation of the residue error in ARX; (C) shows the AR-ARX parameters which is used to compare with the present time history; and (D) shows the ratio of residue error which is received wirelessly from wireless sensing unit.

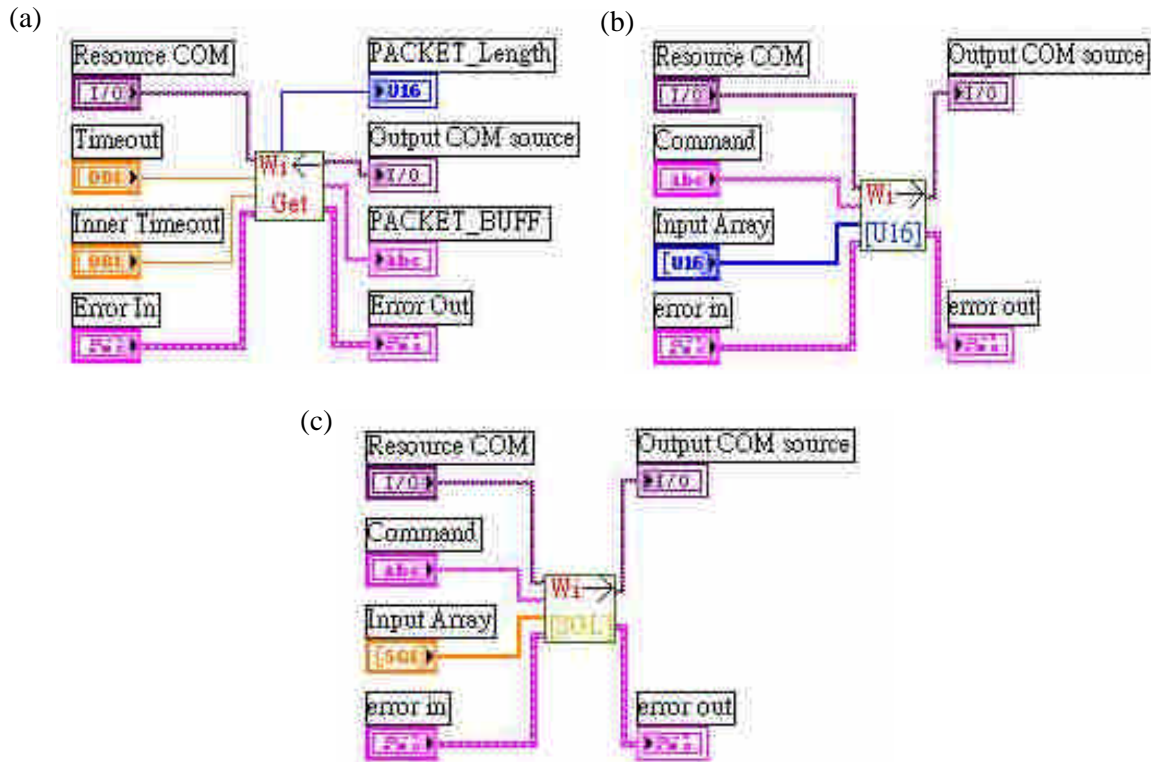

Figure 8: (a) Receive Wireless Package VI, (b) Transmit Wireless Unsigned short, (c) Transmit Wireless single float .

CONCLUSIONS

This research work has explored the use of wireless sensing unit for structural health monitoring. With the suitable embedded program in the microprocessor of sensing unit the online damage detection of structure can be estimated. The AR-ARX damage detection method has been proved a suitable algorithm within the wireless monitoring system for autonomous execution. To validate the approach, a series of shaking table test of RC frame structure and low level white noise excitation are used, the embedded damage detection algorithm is shown to exhibit sufficient sensitivity to identify damage.

ACKNOWLEDGMENTS

This research was supported by National Science Council, Taiwan, under grant number NSC 95-2625-Z-002-032 and NSC 94-2915-I-492-C08. Technical and experimental supports from National Center for Research on Earthquake Engineering are much appreciated.

REFERENCES

(a)

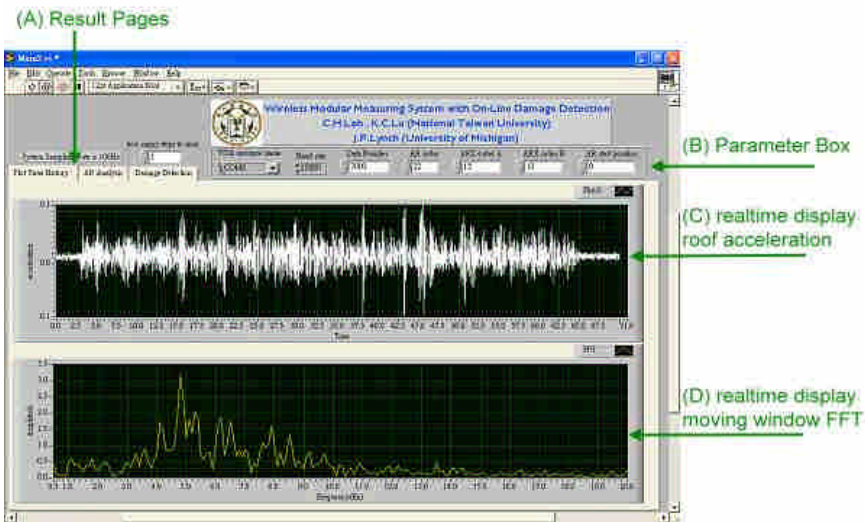

(b)

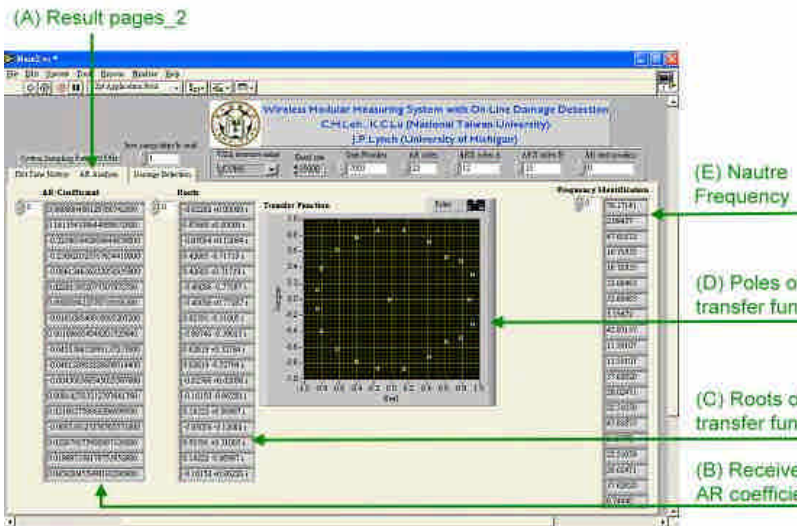

(c)

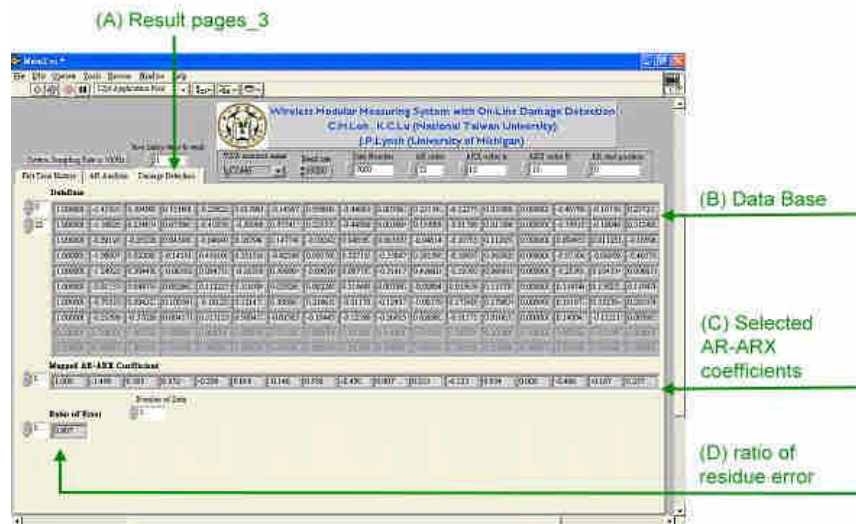

Figure 9: Three pages to display from the wireless health monitoring system: (a) Real-time display, (b) AR analysis, (c) Damage Detection.

- Ying Lei, Anne S. Kiremidjian, K. Krishnan Nair, Jerome P. Lynch and Kincho H. Law, "Algorithms for time synchronization of wireless structural monitoring sensors," *Earthquake Engng. Struct. Dyn.* 34, 555-573, 2005.
- Wang, Y., Lynch, J. P. and Law, K. H., "A wireless structural health monitoring system with multithreaded sensing devices: design and validation," *Structural and Infrastructure Engineering*, in press, 2005.
- Doebbling, S. W., Farr, C. R., Prime, M. B., and Shevitz, D. W., "Damage identification and health monitoring of structural and mechanical systems from changes in their vibration characteristics: A literature review," Los Alamos National Laboratory, Tech. Rep., May, 1996.
- Lei, Y., Kiremidjian, A. S., Nair, K. K., Lynch, J. P., Law, K. H., Kenny, T. W., Carryer, E., and Kottapalli, A., "Statistical damage detection using time series analysis on a structural health monitoring benchmark problem," *Proc. 9th International conference on Application of Statistics and Probability in Civil engineering ICAPS-9*, San Francisco, US, 2003.
- Sohn, Hoon and Farrar, C. R., "Damage diagnosis using time series analysis of vibration signals," *Smart Materials and Structures*, 10, 446-451, 2001.
- Lynch, J. P., Sundararajan, A., Law, K. H. and Kiremidjian, A. S., "Embedded algorithms in a wireless structural monitoring system," *Proc. of Int. Conf. on Advances and New Challenges in Earthquake Engineering Research (ICANCEER02)*, Hong Kong, China August, 2002.
- Lynch, J. P., Wang, Y, Lu, K. C., Hou, T. C. and Loh, C. H., "Post-seismic damage assessment of steel structures instrumented with self-interrogating wireless sensors," *Proc. of the 8-th U.S. National Conf. on Earthquake Engineering*, paper No. 1390, San Francisco, US, April, 2006.
- McKenna, F. and Fenves, G. L. (2000). "An Object-oriented Software Design for Parallel Structural Analysis," *Proceedings of Advanced Technology in Structural Engineering, Structures Congress 2000*, Philadelphia, Pennsylvania, USA, May 8-10. (Software available at <http://opensees.berkeley.edu/>)